

0 601 940 703

Issue } 08-04-25
Stand }

Fig./Abb. 2

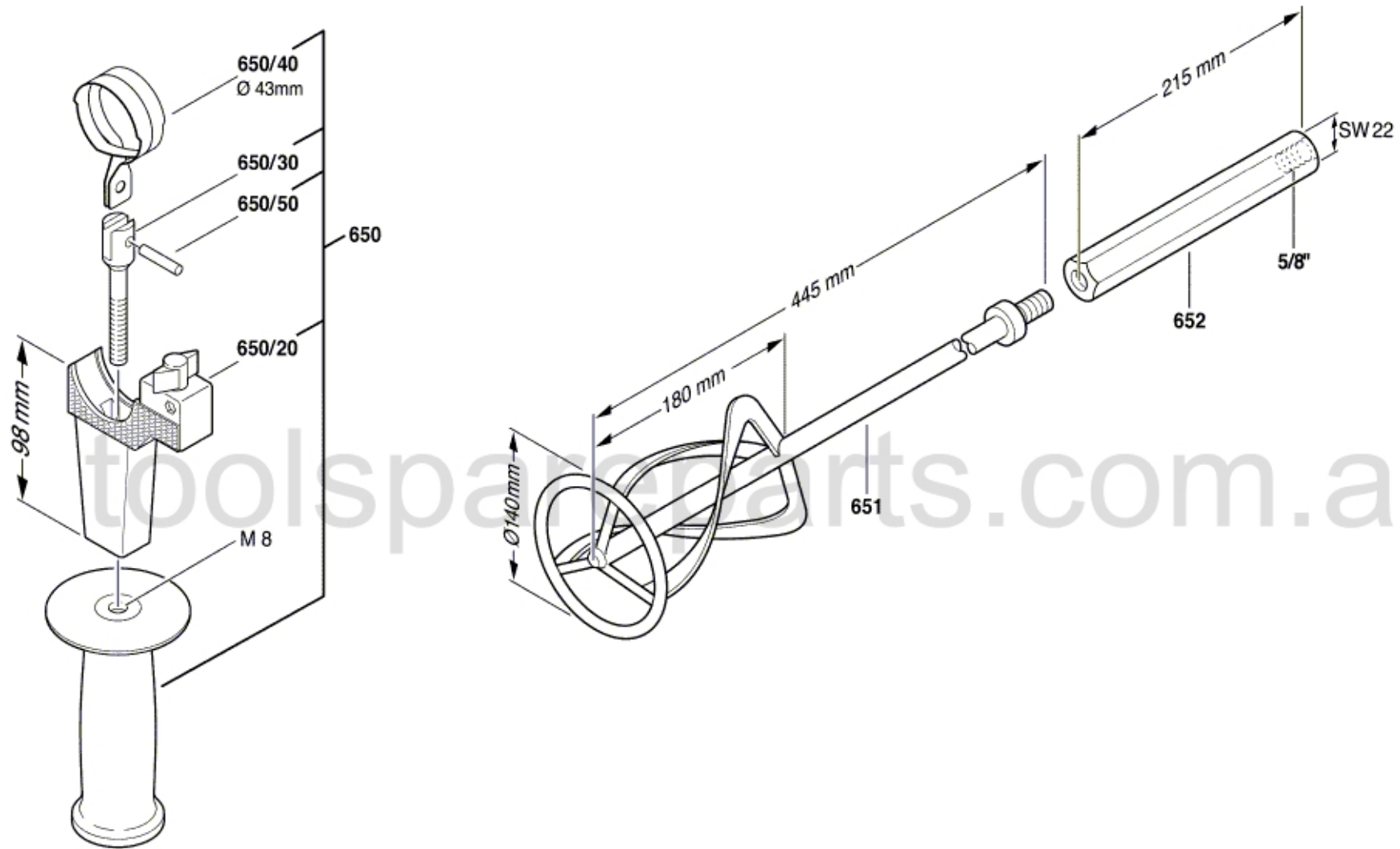

Modifications reserved
Änderungen vorbehalten
Modifications réservées
Salvo modificaciones